



FICHA TÉCNICA | DATASHEET | FICHE TECHNIQUE | FICHA TÉCNICA

ORIENT MÓVEL | ORIENT FURNITURE | ORIENT MEUBLE | ORIENT MUEBLE

Modelos disponíveis | Available models | Modèles disponibles | Modelos disponibles

Altura | Height | Hauteur | Altura : 35 cm

Profundidade | Depth | Profondeur | Profundidad : 45 cm

60cm

80cm

100cm

120cm

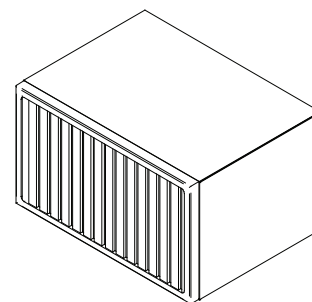
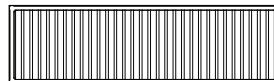
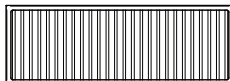
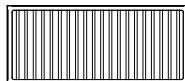
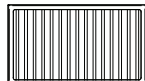

Espaço de canalização
Plumbing space
Espace plomberie
Espacio de fontanería

Detalhes

Details

Détails

Detalles



Espeçura: Fundo e Laterais
Thickness: Bottom Sides
Épaisseur: Fond et Côtés
Espesor: Fondo y Lados



Espeçura: Frente
Thickness: Front
Épaisseur: Façade
Espesor: Frente



Lacado
Lacquered
Laqué
Lacado



Material: MDF
Material: MDF
Matériau: MDF
Material: MDF



Suspensão
Suspended
Suspendus
Suspendidos



Extração Total
Total Extraction
Extraction Totale
Extracción Total



Fecho Suave
Soft-Close
Fermeture en Douceur
Cierre Suave



Abertura Click
Click Opening
Cliquez sur l'ouverture
Haga clic en Abrir

Vista Traseira
Back view
Vue arrière
Vista trasera

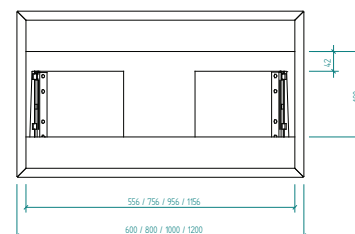

Vista lateral
Side view
Vue de côté
Vista lateral

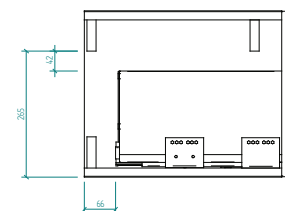

Acabamentos

Finishes

Finitions

Acabados



Branco
White
Blanc
Blanco



Preto
Black
Noir
Negro



Antracite
Anthracite
Anthracite
Antracita



Cinza
Grey
Gris
Gris



Azul Meia-Noite
Midnight Blue
Bleu Nuit
Azul Medianoche



Verde Oliveira
Olive Green
Olive Verte
Verde Oliva



Cashmere
Cashmere
Cashmere
Cashmere

Mate - Matte - Mate - Mate

Texturas - Textures - Textures - Texturas



Teka
Teak
Teka
Teca



Nogal
Walnut
Noyer
Nogal

Instalação

Installation

Installation

Instalación

- A instalação deverá ser efetuada por um técnico habilitado.
- The installation should be carried out by a qualified technician
- L'installation doit être effectuée par un technicien qualifié
- La instalación debe ser realizada por un técnico habilitado

Certificados de qualidade
Quality certificates
Certifications de qualité
Certificados de calidad



EN 14428:2008 + A1:2010
ISO 9001:2015

GARANTIA E MANUTENÇÃO | WARRANTY AND MAINTENANCE | GARANTIES ET ENTRETIEN | GARANTÍAS Y MANTENIMIENTO

- Garantia 5 anos para defeitos de fabrico (excluem-se peças de desgaste rápido)
- 5 years warranty for manufacturing defects (The normal abrasion of wear parts is excluded from our warranty.)
- 5 ans de garantie pour les défauts de fabrication (Sont exclus de la garantie les pièces d'usure)
- 5 años de garantía para defectos de fabricación (Queda excluido de la garantía el desgaste por su uso normal)
- Limpar com pano húmido
- Clean with damp cloth
- Nettoyer avec un chiffon humide
- Limpiar con un paño humedecido
- Não usar detergentes abrasivos
- Do not use abrasive detergents
- Ne pas utiliser des produits abrasifs
- No usar detergentes abrasivos
- Secar depois de limpar
- Dry after cleaning
- Sécher après nettoyage
- Secar después de limpiar